

25 kN
GSZ-25-R | rotating screw

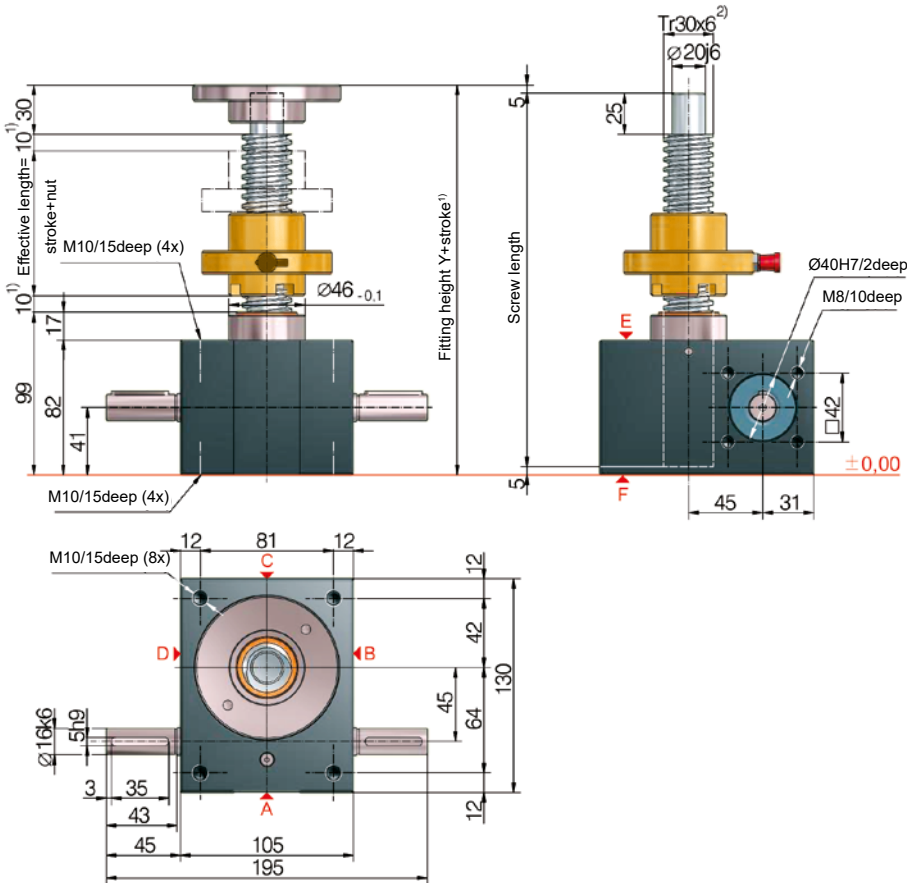

Standard configuration

Code	Gearbox (series)	Size	Version (variant)	Ratio	Screw	Stroke per drive shaft rotation
GSZ-25-RN	GSZ	25	R (rotating screw)	N (normal) 6:1	Tr 30x6	1,00 mm
GSZ-25-RL				L (low) 24:1		0,25 mm

25 kN

Duty cycle thermal limit

Ratio „N“ (6:1)

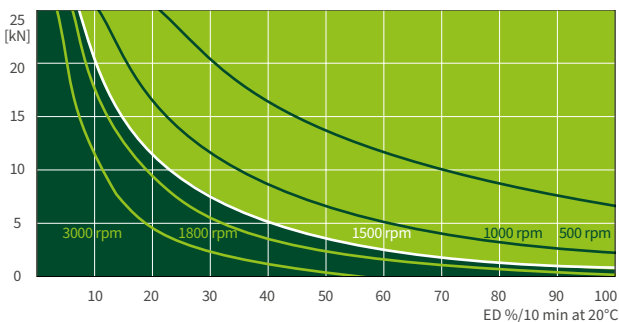

Ratio „L“ (24:1)

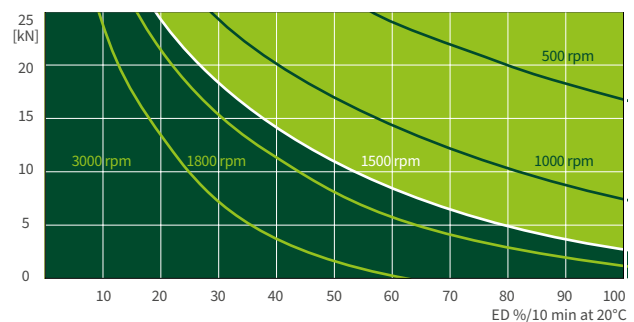

These curves are for guidance under standard industrial conditions (ambient temperature 20°C etc.) and correct maintenance (lubrication etc.). They are based on the ZIMM standard trapezoidal thread Tr 30x6. The operation cycles can be many times longer, when using ball screws.