

5 kN
ZE-5-R | rotating screw

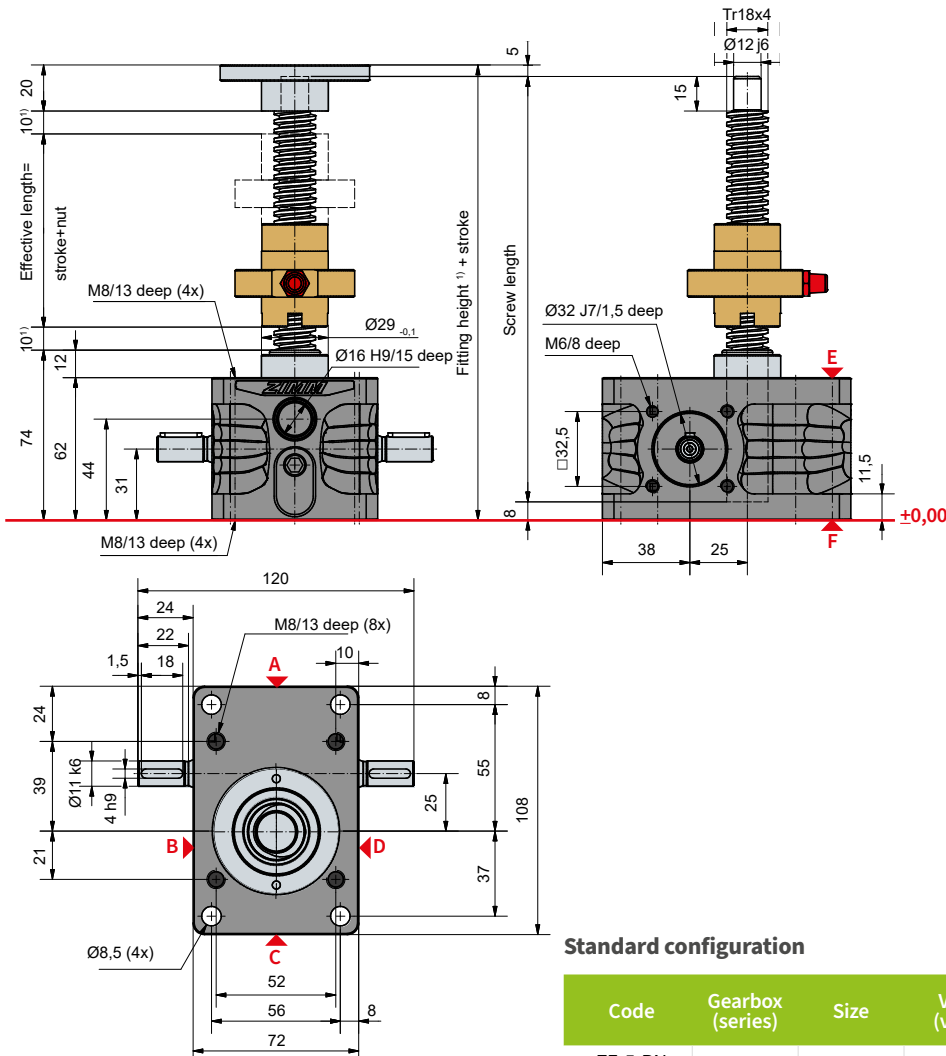

Standard configuration

Code	Gearbox (series)	Size	Version (variant)	Ratio	Screw	Stroke per drive shaft rotation
ZE-5-RN	ZE	5	R (rotating screw)	N (normal) 4:1	Tr 18x4	1,00 mm
ZE-5-RL				L (low) 16:1		0,25 mm

5 kN

Duty cycle thermal limit

Ratio „N“ (4:1)

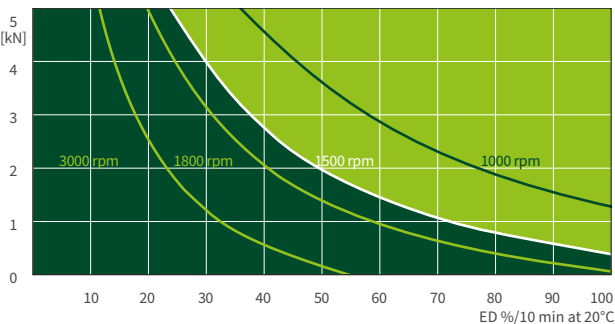

Ratio „L“ (16:1)

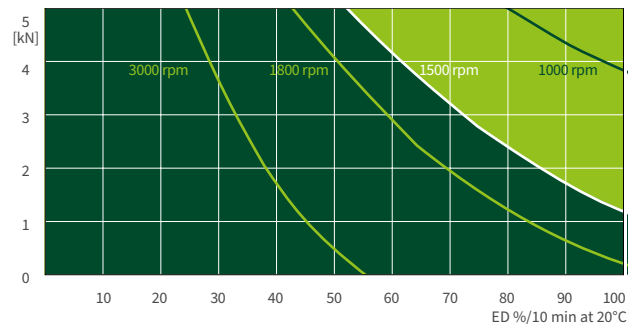

These curves are for guidance under standard industrial conditions (ambient temperature 20°C etc.) and correct maintenance (lubrication etc.). They are based on the ZIMM standard trapezoidal thread Tr 18x4. The operation cycles can be many times longer, when using ball screws.