

Three-phase AC motors

Overview | 0,09 kW - 75 kW

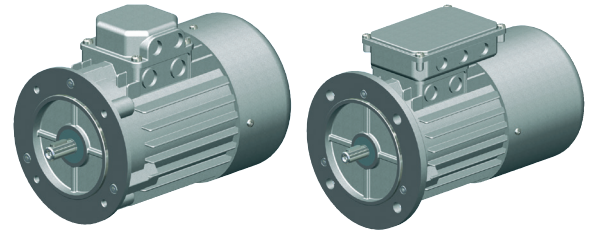

Technical data

Standard three-phase motors (asynchronous)
 No-load speed ~1500 rpm (other speeds on request)
 230/400 V Δ 50 Hz, S1 or S3-75%, ISO F
 Three-phase AC motors: IP 55
 Three-phase AC motors with brakes: IP 54

Voltage ranges:

220 - 240 V Δ 50 Hz 380 - 415 V Y 50 Hz
 380 - 415 V Δ 50 Hz 660 - 690 V Y 50 Hz

Size	Power P	Rated speed	Rated torque	Rated current at 400 V	for direct-on-line starting		Breakdown torque to rated torque	Moment of inertia J	Efficiency (at 100% load)	Power factor (at 100% load)	Weight without brake	Weight with brake
IEC	kW	rpm	Nm	A	Starting current to rated current I _s /I _N	Starting torque to rated torque M _s /M _N	M _k /M _N	approx. kgm ²	η %	cos	approx. kg	approx. kg
56	0,09	1300	0,66	0,35	2,5	1,8	2	0,0002	50	0,76	2,7	4
63	0,18	1330	1,3	0,65	2,3	1,9	1,9	0,0003	58	0,7	4,1	6
63	0,25*	1340	1,81	0,94	2,2	1,7	2,5	0,0004	60	0,76	4,2	6,5
71	0,37	1360	2,6	1,2	2,8	2	2	0,0008	63	0,7	6	8
71	0,75*	1370	5,33	2,1	2,9	2,1	2,4	0,0012	69	0,78	8,3	10,3
80	0,75	1410	5,1	2	4,5	2,2	2,8	0,0020	70	0,7	9,3	13
80	1,5*	1390	10,4	3,4	4,1	3,2	3,2	0,0026	72	0,7	11,5	15,2
90L	1,5	1410	10,3	3,7	4,9	3	3	0,0032	79	0,74	14,4	18
90L	2,2*	1400	15,2	5,2	4,5	2,7	2,7	0,0039	78	0,81	17,5	21,1
100L	2,2	1420	14,8	5,3	4	2,3	2,7	0,0046	83	0,74	19,2	25,5
100L	3	1410	20,3	6,7	3,9	2,3	2,5	0,0056	82	0,79	22,4	28
100L	4*	1420	27	8,9	4	2,2	2,2	0,0065	81	0,82	26,3	31,9
112M	4	1440	27	9,4	3,3	2,5	2,9	0,0133	83	0,75	30,4	38
112M	5,5*	1440	36,4	11,7	3,9	2,1	2,3	0,0139	84	0,83	33	40,6
132S	5,5	1440	36	12	5,8	3	3	0,024	83	0,8	41,9	56
132M	7,5	1440	50	15,4	6,8	3,1	3,1	0,0293	86	0,82	51	66
132M	11*	1445	73,1	24,5	8,2	3,5	3,5	0,0458	83	0,8	74	89
» 160M	11	1460	72,1	20,7	7,6	2,1	2,4	0,0832	89,1	0,86	101	111
» 160L	15	1460	96,2	29,2	7,1	2,4	2,6	0,1506	89,4	0,83	110	120
» 180M	18,5	1465	119	34,3	7,1	2,3	2,6	0,1773	90,4	0,86	135	150
» 180L	22	1475	142	41,1	6,9	2,4	2,6	0,2936	90,9	0,85	145	160
» 200L	30	1475	190	54	6,6	2,1	2,3	0,6345	92,1	0,87	230	253
» 225S	37	1470	238	64,7	7	2,3	2,5	0,3251	92,8	0,89	338	361
» 225M	45	1470	286	77,9	7,4	2,3	2,4	0,7866	92,6	0,9	358	381
» 250M	55	1465	359	94	7,5	2,6	2,6	0,9483	93,4	0,9	482	517
» 250ML	75	1480	484	134	6,3	1,2	2,2	0,9988	94	0,8	535	570

Size 63 to 132 available on short lead times
 *Power is higher than the IEC-Norm (progressive)
 » Size 160 to 355 available on request

CAUTION

Overdimensioning the motor power risks overstressing other components. The effects must be considered not only under load but also for the no-load case.

We supply **motor brakes** as standard for a connection voltage of 230V AC, operating voltage 205 V DC, with bridge rectifiers.

Ordering example:

90-P4-1,5-B5-B-2W

Size _____
 Number of poles - speed 4-pole = 1500 min⁻¹ _____
 Power [kW] _____
 Design _____
 with brake (if required) _____
 with a second shaft end (if required) _____

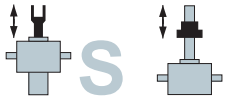

Three-phase AC motors

General information

Connection arrangement

The motors usually have a terminal board with 6 terminals and a protective earth terminal in the terminal box. The stator winding can be switched into star or delta connection using the connection links.

Star/delta starting is not suitable for screw jack systems because full torque is required immediately on starting.

For motor windings 230/400V (example):

Δ - Connection

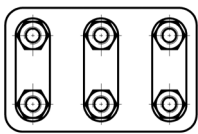

3~ 230V

Y - Connection

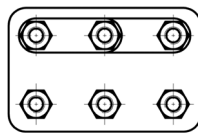

3~ 400V

Operating voltage 230V delta:

Motor windings 230/400V

Operating voltage 400V star:

Motor windings 400/660V

Direction of rotating

Motors can be arranged for either direction of rotation. When the line phases L1, L2, L3 are connected to the motor terminals U1, V1, W1, the direction of rotation is clockwise. Swapping over two of the supply lines reverses the direction of rotation.

Speeds

Three-phase AC motors have different rotational speeds depending on the number of poles. Generally we recommend our standard motor with 1500 rpm (4 poles). Other numbers of poles are available on request. Pole-changing motors allow a choice of 2 different rotational speeds.

Speed (50 Hz)	Number of poles
3000	2
1500	4 (= preferred type)
1000	6
750	8
500	12

Geared motors

Geared motors are available for particular projects on request.

Operation with frequency converters

Especially for larger screw jacks and systems, we recommend the use of a frequency converter to achieve smooth start-up and brake ramps. This minimizes start-up noise and extends the service life of the gearbox.

When operating with a frequency converter, remember that if the motor is to be operated for extended periods at frequencies less than 25 Hz, its fan must be driven separately. This is necessary to ensure adequate motor cooling. When operating a braked motor with a frequency converter, a separate actuation line for the brake must be provided via the frequency converter.

Braked motors

We recommend using a braked motor to minimize the overrun time of the system. Where a screw jack is fitted with a ball screw or a double-pitch screw, a braked motor is absolutely essential. We supply motor brakes as standard for a connection voltage of 230V AC / operating voltage 205V DC, with bridge rectifiers. Other connection voltages (24V DC, 400V AC, 500V AC) are available on request.

Temperature monitoring

Generally we do not supply temperature monitoring because screw jack duty cycles are normally quite low or the motor is adequately dimensioned. Most standard motors above 1.5 kW are equipped with PTC. Versions with bimetal switch (TH), Temperature control thermal resistor PTC (TF) and combined are available on request.

Some types are available ex stock with thermal resistor (PTC).

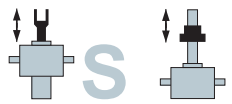

Three-phase AC motors with brakes

Flange profile B14B, large flange

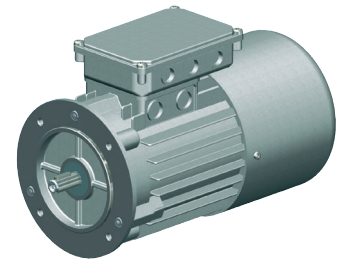
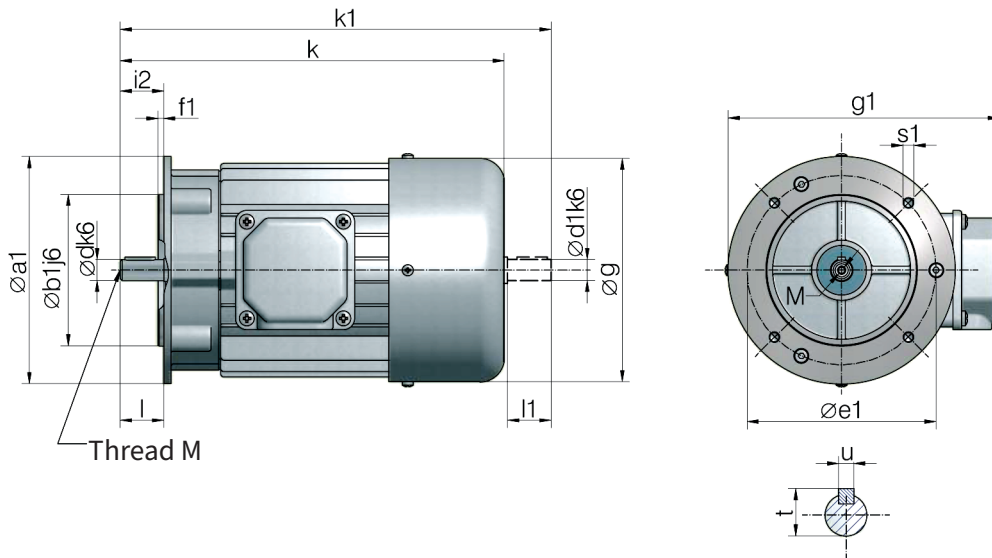

B14: Flange with internal thread
B: Large flange

Size	a1	b1	e1	f1	g	i2	s1	d	l	t	u
63	120	80	100	3	125	23	M6	11	23	12,5	4
71	140	95	115	3	141	30	M8	14	30	16	5
80	160	110	130	3,5	159	40	M8	19	40	21,5	6
90	160	110	130	3,5	179	50	M8	24	50	27,5	8
100	200	130	165	3,5	199	60	M10	28	60	31	8

Size	kW (4-pole)	without brake				with brake		with brake and second shaft end			g1	M
		k	k1	d1	l1	k	k	k1	d1	l1		
63	0,18	212	238	11	23	261	261	285	9	20	172	4
63	0,25	212	238	11	23	239	261	285	9	20	172	4
71	0,37	248	281	14	30	263	295	325	11	23	188	5
71	0,75	248	281	14	30	263	295	325	11	23	188	5
80	0,75	277	315	19	40	305	330	375	19	40	211	6
80	1,5	277	315	19	40	305	330	375	19	40	211	6
90	1,5	329	378	24	50	390	390	432	19	40	227	8
90	2,2	329	378	24	50	348	390	432	19	40	227	8
100	3	369	429	28	60	433	433	487	24	50	248	10
100	4	369	429	28	60	433	433	487	24	50	248	10

We reserve the right to change the dimensions without changing the motor designation.